

Image Processing Applied to uv Photo of the Shroud of Turin which Includes the Radiocarbon Test Area

by

Thomas Mc Avoy

Institute for Systems Research, University of Maryland, College Park, MD, 20742

Abstract:

In an earlier paper (Morgan, 2012) applied an image processing technique that is used in analyzing geographic photos to a uv photo of the Shroud of Turin taken by Vern Miller in 1978. The technique involved principal component analysis, a dimensionality reduction method. It was found that the first principal component explained 97.41% of the variance in the Shroud photo. The first principal component is very highly correlated with the intensity of the uv Shroud photo. When the first principal component was calculated for the radiocarbon test regions it was found statistically that the first principal component values in these regions were anomalous compared to those of a typical region in the Shroud photo used to build the principal component model. It was concluded that the radiocarbon test regions were different from the main regions of the Shroud, suggesting that the radiocarbon dates may be invalid. This paper re-examines the approach by Morgan and demonstrates that the variation in the first principal component could be due to the way the Shroud was illuminated when the uv photo was taken. When Miller took uv Shroud photos the light used was focused on the middle of an area of the Shroud being photographed. As a result regions away from the middle, such as the radiocarbon test area, did not receive the same uv intensity as those near the middle, and thus their reflected intensity would be smaller. By contrast when geographic photos are taken uniform illumination is provided by the Sun. Thus, Morgan's statistical conclusions can be questioned. Regular color photos taken by Vern Miller employed a different illumination approach than that for the uv photos. Applying Morgan's approach to these color photos suggests that the radiocarbon region may indeed be anomalous. Whether the regular photos were illuminated uniformly needs to be studied further.

INTRODUCTION

Many people believe that the Shroud of Turin is Christ's burial cloth and thus that it dates to the first century AD. The Shroud has been studied more than any other ancient relic in history. In 1988 radiocarbon dating by three laboratories (Damon et al, 1989) indicated that the Shroud dated from medieval times with a range of dates from 1260 to 1390. Even though the statistics used by (Damon et al, 1989) were flawed and their radiocarbon dates showed a bias (Van Haelst, 1999), many people currently believe them and believe that the Shroud is a forgery.

In an earlier paper (Morgan, 2012) raised questions about the samples used for the radiocarbon dating. He applied an image processing technique that is used in analyzing geographic images (Clark Labs, IDRISI GIS and Image Processing Software, 2011) to a uv photo of the Shroud of Turin taken by Vern Miller in 1978. The GIS technique involved principal component analysis (PCA) (Hotelling, 1933), a dimensionality reduction method. The PCA method was applied to the entire Shroud image, and it was found that the first principal component explained 97.41% of the variance in the Shroud photo. A typical region in the Shroud photo, the sample area, was used to calculate average PCA properties for the image. When the first principal component was calculated for the radiocarbon test regions, it was found statistically that these regions were anomalous. It was concluded that the radiocarbon test regions were different from the main region of the Shroud, suggesting that the radiocarbon dates were invalid.

In 1978 Vern Miller as a member of the Shroud of Turin Research Project (STURP) took approximately 200 high quality photos of the Shroud. In 2019 all of Miller's photos were published on the web (Miller, 2019). For his paper (Morgan, 2012) Morgan downloaded a cropped photo which included the radiocarbon dating region from a web site that is no longer available (Shroud Science Group page on yahoo.com). In this paper an alternative but identical copy of Morgan's photo and Vern Miller's original photos are used in the analysis that is presented.

This paper re-examines the approach in (Morgan, 2012) to study whether the variation in the first principal component could be due to the way the Shroud was illuminated when the uv photo was taken. When Miller took uv Shroud photos the two lights used were focused on the middle of an area of the Shroud being photographed. As a result regions away from the middle, such as the radiocarbon test area, did not receive the same uv intensity as those near the middle, and thus their reflected intensity can be expected to be smaller than that in the middle area. The question addressed in this paper is whether the way the Shroud was illuminated affected the PCA analysis. By contrast when geographic photos are taken uniform illumination is provided by the Sun. The lack of uniform illumination in the uv Shroud images was noted in an earlier publication analyzing these images (Avis, 1982).

In addition to analyzing Miller's uv images, one non-uv color image is analyzed. The lighting arrangement for Miller's color photographs was different than that used for the uv photos and it provided more uniform illumination.

MATERIALS AND METHODS

For his paper (Morgan, 2012) downloaded a photo of the Shroud showing the radiocarbon test area from the Shroud Science Group web page on yahoo.com. Since this web site is no longer available,

an alternative image is used in this paper. The image used by Morgan appears identical to that in Figure 18 in (Rogers, 2002). The agreement between Figure 18 and Morgan's image can be seen by comparing Figure 18 to Figure 1 in (Morgan, 2012). To begin the analysis in this paper a copy of Figure 18 was obtained by cropping a screenshot of it from (Rogers, 2002). This photo is shown in Figure 1 with both the radiocarbon test areas and Morgan's sample area indicated.

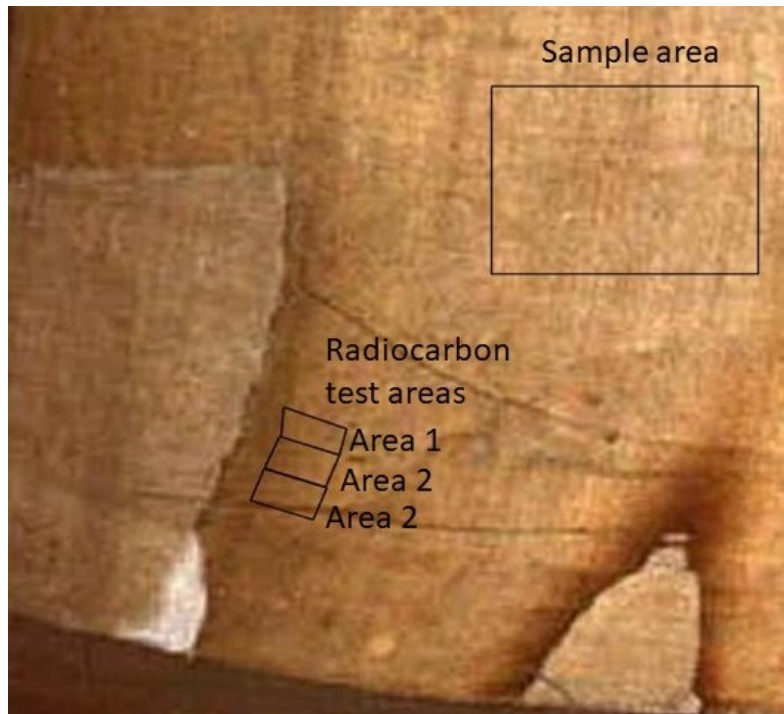

Figure 1. Copy of Vern Miller uv Photo from (Rogers, 2002) with Radiocarbon test areas and sample area added

The sample area was chosen to match the sample area in Figure 11 of (Morgan, 2012). Figure 8 of (Morgan, 2012) was matched using MATLAB[®] software (<https://www.mathworks.com/>) to give the radiocarbon test areas. MATLAB[®] is marketed by MathWorks an American privately held corporation that specializes in mathematical computing software. Morgan used Corel Paint Shop Pro to reduce the image color depth for his study. As a result the image used here has more pixels than the image analyzed by Morgan. In the following section Morgan's statistical analysis is briefly repeated to demonstrate the validity of using the alternative image shown in Figure 1.

Two of Vern Miller's 1978 4x5 color transparency uv images were downloaded from the web (Miller, 2019), and for the analysis below they were cropped to remove the border. For explanation purposes an uncropped images which shows the radiocarbon test area is shown in Figure 2 (image 175 4g-UV-S2-B-22_0491). Figure 3 shows a cropped image near the side wound (image 179 5d-UV-S2-D-15_0496). These images are very dense with pixel dimensions for both figures of 8176x6132. For image analysis these two figures were resized to reduce their pixel dimensions to 2208x1811 for Figure 2 and 2005x1994 for Figure 3. Comparing Figures 1 and 2 it can be seen that Figure 1 appears to be a cropped version of the left hand corner of the Shroud in Figure 2.



Figure 2. Uncropped Miller image 175 (4g-UV-S2-B-22_0491) © Vernon Miller, 1978.



Figure 3. Cropped Miller image 179 (5d-UV-S2-D-15_0496) © Vernon Miller, 1978.

In taking his uv photos Miller used the setup shown in Figure 4 (Miller, and Pellicori, 1981).

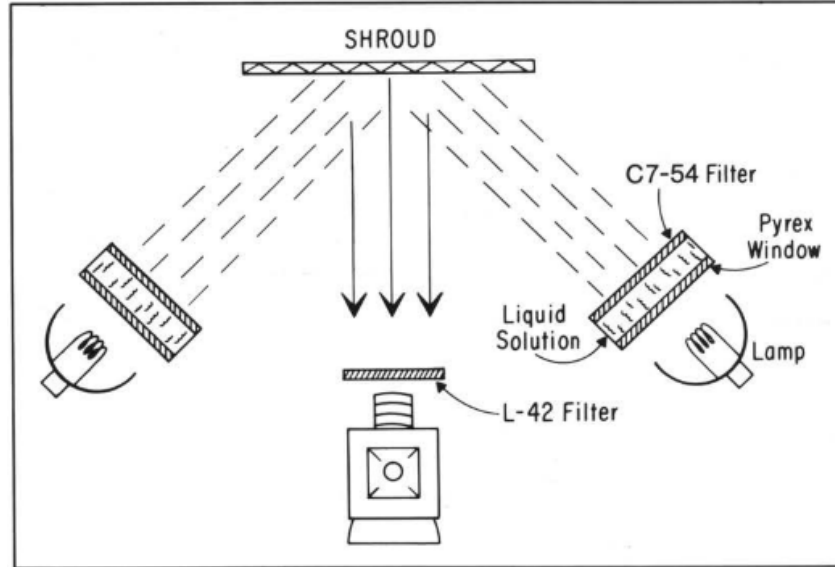

Figure 4. Lighting configuration used by Miller for uv photography. Two uv lamps were focused on the Shroud at 45° angles. The camera had a uv filter and photographed at a 90° angle.

Two 200 watt uv lamps were focused on the center point of the Shroud region where the photo was taken.

Figures 1 to 3 are RGB (red green blue) images. In addition to the RGB color space there are a number of other color spaces. Figure 5 shows a schematic of the CIE L*a*b color space (https://en.wikipedia.org/wiki/CIELAB_color_space). This color space is designed to approximate human vision.

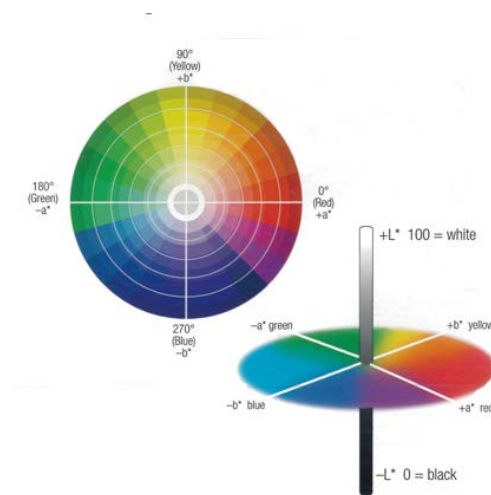

Figure 5. CIE L*a*b Color Space

The vertical L axis in the CIE L*a*b space gives image intensity. The two horizontal axes, a and b, give image color. MATLAB® and its Image Processing Toolbox are used to analyze images in this study. The Image Processing Toolbox has subroutines that allow one to convert an RGB image to a CIE L*a*b image and vice versa. MATLAB® also has many statistical and plotting routines that are used in the analysis below.

RESULTS AND DISCUSSION

Repeat of Morgan's Statistical Analysis

Morgan's statistical analysis (Morgan, 2012) is briefly considered here. PCA (Hotelling, 1933) was carried out on the entire image in Figure 1 by first scaling the raw pixel data to zero mean and unit variance. It was found that the first principal component explained 96.79% of the variance in the image, compared to Morgan's result of 97.41% explanation. The same one-sample z-test used by Morgan was used to determine whether the radiocarbon dating areas were statistically different when compared to the square sample area. This z-test compares the mean of the first PCA score of radiocarbon test areas to the mean of first PCA score of the sample area. Morgan considered two hypotheses, H_0 which was that there was no difference in means and H_1 that the means differed. Rejection criteria were based on a 95% confidence interval. The test statistic for the z-test is defined by the following equation

$$z = (X - \mu) / \left(\frac{\sigma}{\sqrt{n}} \right)$$

where X is a radiocarbon test area score mean, μ is the population mean taken as the sample area score mean, σ is the population standard deviation taken as the sample area score standard deviation, and n is the sample size taken as the number of pixels in each radiocarbon test areas. Table 1 gives selected statistics for the first PCA scores for the three radiocarbon test areas for which dates were reported together with the same variables for the square sample area. Area 4 in (Morgan, 2012) is not considered here since radiocarbon dating results were not published for this region. Table 1 corresponds to Table 2 in (Morgan, 2012).

Table 1. Selected statistics of PC 1 scores for 3 radiocarbon sample areas and square sample area

Statistic	Area 1	Area 2	Area 3	Sample Area
Min. Value	-2.2741	-2.4239	-3.5063	-0.6404
Max. Value	0.0071	0.3118	0.0928	4.2067
Mean	-0.9342	-1.1080	-1.4437	1.7939
Standard deviation	.4162	.6724	.6586	.6816
No. of pixels	965	1189	1207	27000

The results of calculating z for each of the three radiocarbon test areas are given in Table 2 which should be compared to Table 3 in (Morgan, 2012). The differences in the means between the radiocarbon test areas is large and as a result hypothesis H_0 is rejected by the z-test in agreement with (Morgan, 2012)

Table 2. One sample z-test for three radiocarbon test areas.

Statistic	Area 1	Area 2	Area 3
n	965	1189	1207
Area mean (X)	-.9342	-1.1080	-1.4437
z-test value	-124.3	-146.8	-165.0
Test result	Reject H_0	Reject H_0	Reject H_0

When Figure 1 is recast into the CIE L*a*b color space then for all the pixels a correlation coefficient of 0.9953 is obtained between the first PCA score and the intensity L in the CIE L*a*b color space. This result indicates that the first PCA score is essentially equal to the image intensity.

Analysis of Miller's 1978 uv Photos

To explain the result in Table 2 Miller's original 1978 uv photos can be analyzed (Miller, 2019). The MATLAB[®] function contour(Y) creates a contour plot containing the isolines of matrix Y, where Y contains height values on the x-y plane. For Miller's uv images Y would contain the image intensity values, L, for each pixel in a uv image. Figures 6 and 7 give the contour plots for the intensity variable L for cropped Figure 2 and Figure 3.

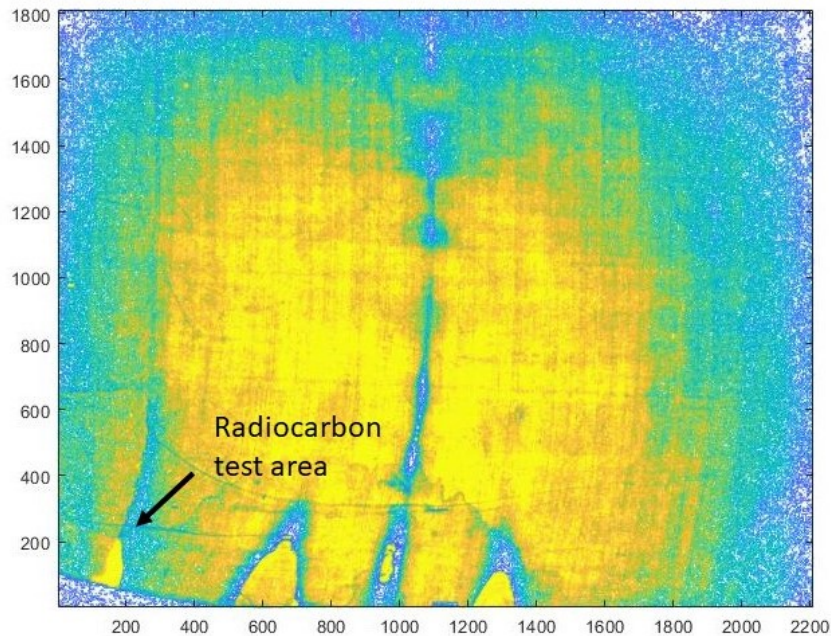

Figure 6. Plot of CIE L*a*b intensity for cropped Figure 2

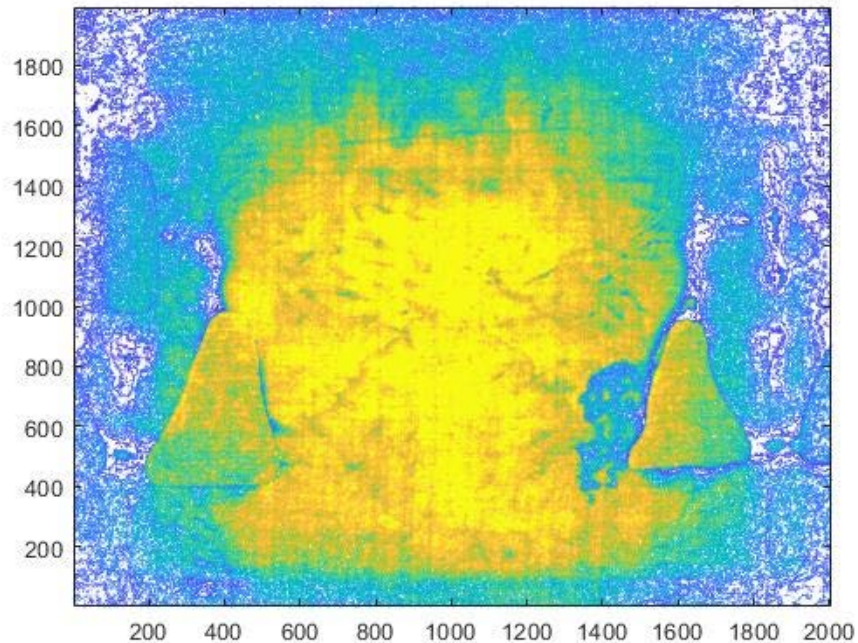

Figure 7. Plot of CIE L*a*b intensity for Figure 3

The bright yellow regions toward the center in both figures are associated with the highest intensities, while the blue/green regions are associated with the lower intensities. The blue regions have a lower intensity than the green regions. Both Figure 6 and 7 clearly show the effects of the uv lighting configuration used by Miller and shown in Figure 4. In Figure 7 the blue/green areas completely surround the yellow area in the center. Six additional uv photos taken by Miller have been contoured in the same way as Figure 7 and they all exhibit the same uneven, circular illumination pattern shown in Figure 7.

In Figure 6 the blue/green regions surround the sides and top of the image. The burn marks on the bottom of Figure 6 and the middle of the image on the bottom show up yellow. The reason that a blue/green region does not show up across the entire bottom of Figure 6 can be explained by referring to Figure 2. When the dark border at the bottom of Figure 2 is cropped to carry out the intensity analysis the center of the original image where the uv light was focused moves lower, and it is closer to the bottom border of the cropped image. Had the Shroud continued below its border in Figure 2 there would have been a surrounding blue/green region in the contour plot in Figure 6. Even with the cropping effect the radiocarbon test area indicated in Figure 6 shows up in a blue/green area. If the z statistic were calculated for a region near the top of Figure 6 the region would have shown up as being anomalous. Figures 6 and 7 as well as those for the other 6 uv photos analyzed but not shown demonstrate that there is a definite uneven intensity of light over the Shroud produced by excitation using the two 45° uv lamps. (Avis, et al 1982) also noted the lack of uniform illumination in the uv Shroud images taken by Miller which they analyzed, and they compensated for the non-uniformity by using a median filter.

Since Figure 1 is no doubt cropped from Figure 2 it suffers from the same uneven illumination issues. Figure 8 shows a contour plot for the intensity, L , in Figure 1. As can be seen except for the 2 burn marks at the bottom of the image, the largest intensities occur on the right side of the image and particularly toward the upper right hand corner of the image. The radiocarbon test area which is shown in the figure has lower intensities, in agreement with the low intensities away from the center in Figures 6 and 7. However, the PCA approach in (Morgan, 2012) assumes equal illumination which Miller's photos do not exhibit. Since the first principal component is very highly correlated with image intensity the statistical conclusions in (Morgan, 2012) that the radiocarbon test areas are anomalous can be questioned. The radiocarbon dating areas may be different from the main Shroud, but because of non-uniform illumination the PCA method cannot be applied to Miller's uv photos to demonstrate this point. In the next section a non-uv color photo taken by Miller is examined.

Analysis of Miller's 1978 Non-uv, Color Photos

In addition to taking uv photos Miller also took standard color photos of the Shroud. For both the color and uv photography the track along which the camera was moved is shown in Figure 9 (Miller, 1982). The camera was kept at a fixed distance from the Shroud by telescoping rod D. The camera could be moved horizontally on the track and its vertical height could also be adjusted. For uv photography two lights focused at 45° were used (Figure 4). For color photography one 1000 watt lamp and 2 500 watt lamps were used (Schwartz, 2019). Importantly, for color photography the illumination of the Shroud was much more uniform than that for the uv photography. In taking color photos the STURP team paid very close attention to the uniformity of lighting that was used (Schwartz, 2019).

Figure 10 shows one of Miller's uncropped color photos that includes the radiocarbon test areas, and Figure 11 gives the contour plot for Figure 10. The yellow areas in Figure 11 represent high intensity and the green/ blue areas lower intensities. When PCA is applied after cropping the border of the image in Figure 10 it is found that 95.93% of the variance in the image can be explained by the first principal component. The correlation coefficient between the image intensity, L , and the first principal component is .9985, indicating that the first principal component is essentially the image intensity.

Two points can be noted about Figure 11. First the large yellow region suggests that the lighting used for taking the photo in Figure 10 was much more uniform than that used for the uv photos. There is no blue border encircling the yellow region in the photo in Figure 11. Secondly, the contour plot indicates that the radiocarbon test areas appear to be different from the rest of the Shroud. The radiocarbon test areas are in the dark blue/green region in the right hand corner of the image. Figure 10 shows that the radiocarbon test areas are darker than the color of the bulk of the Shroud. Indeed (Adler et al, 2002) found the radiocarbon test area to be highly contaminated, especially with inorganic compounds. Additional research on Miller's color photos could be carried out to try to assess if his color photos are uniformly illuminated, and if so how much the radiocarbon test areas differ from the rest of the Shroud. The intensity of pixels in the white tape around the edge holding the Shroud in Figure 10 can be useful in checking image intensity to determine if it is uniform. Given the correlation between image intensity and the first principal

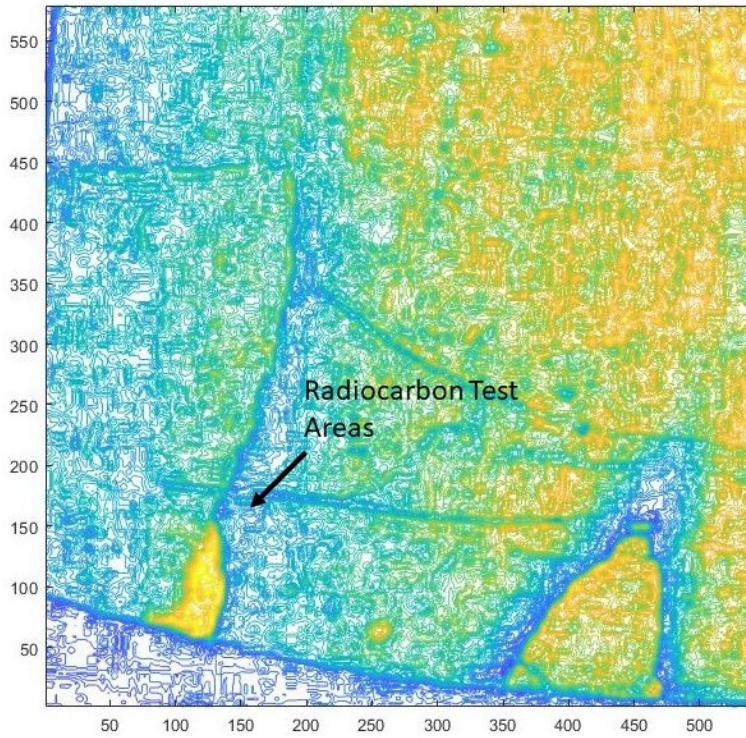

Figure 8. Contour Plot for Intensity in Figure 1.

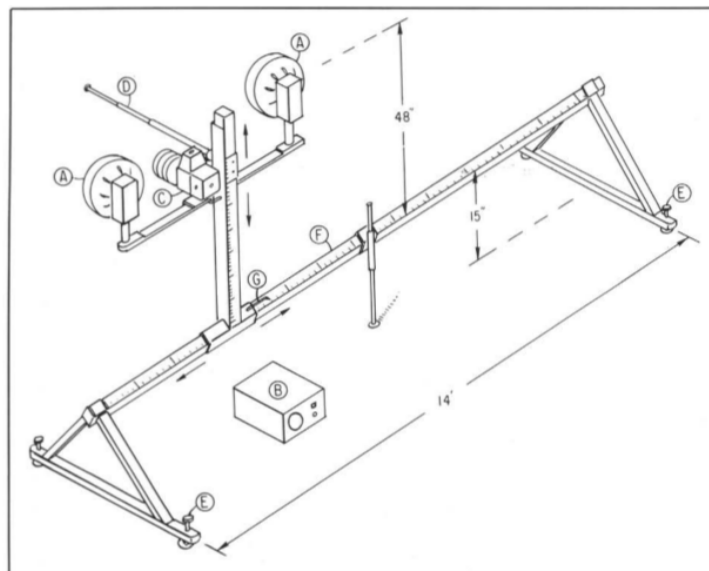

Figure 9. Lighting configuration used by Miller for photography (Miller, and Pelliciori, 1981)

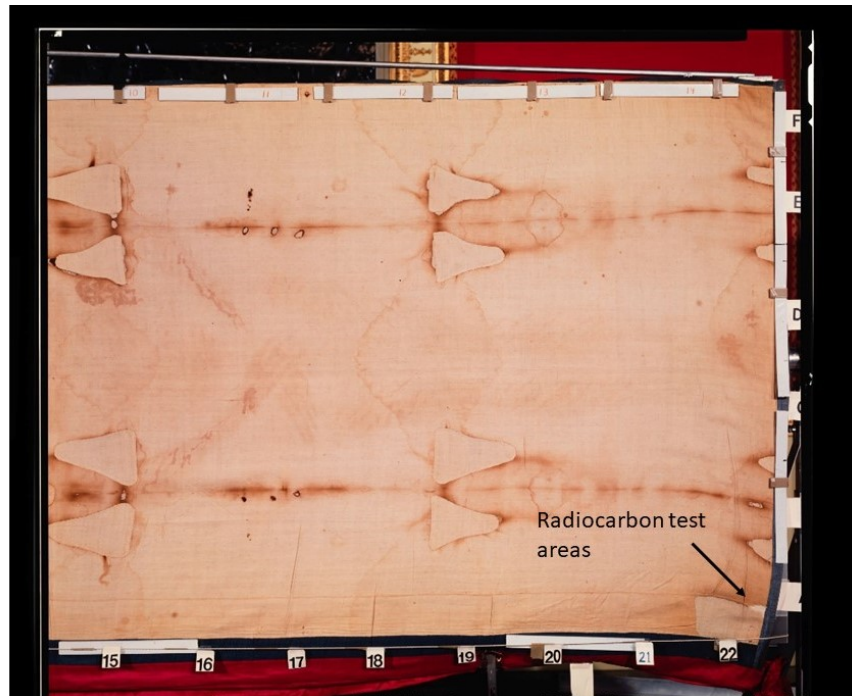

Figure 10. Uncropped Miller image 132 (12-F-TI_0257a) © Vernon Miller, 1978.

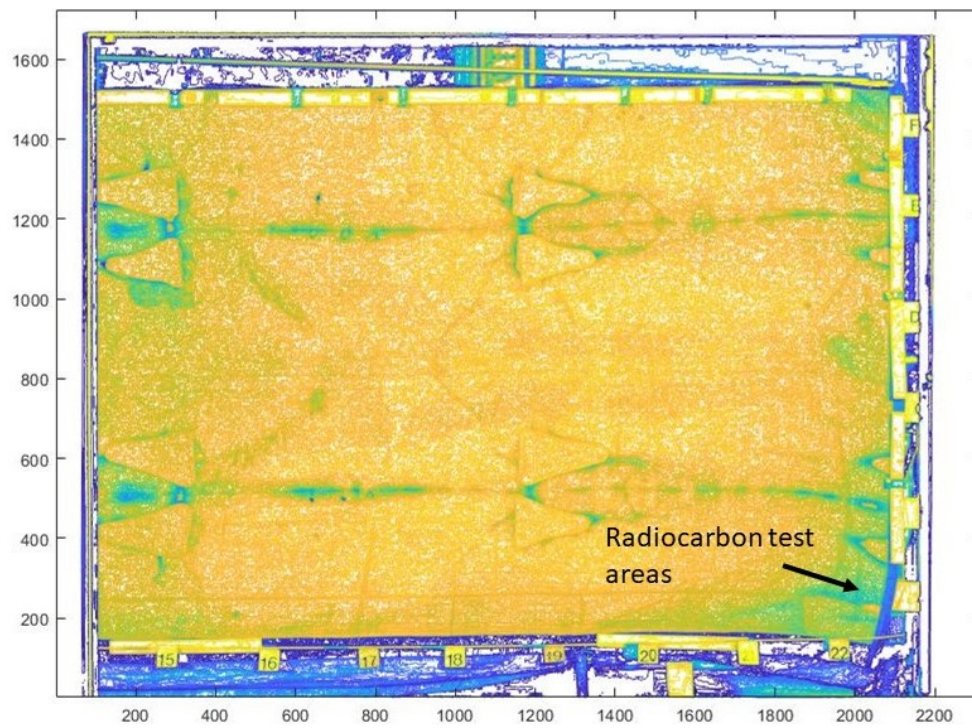

Figure 11. Contour plot for image in Figure 10.

component for this color photo it should be possible to use the PCA methodology given by (Morgan, 2012) for this additional study.

CONCLUSIONS

This paper has examined the conclusions of an earlier paper (Morgan, 2012) that used a geographic signal processing approach on a uv photo of the Shroud of Turin to question the validity of radiocarbon dates for the Shroud. In that paper the area where the radiocarbon samples were taken was found to be statistically anomalous. In this paper it is shown that a key assumption of the geographic signal processing approach, namely uniform lighting, did not hold for the image analyzed, and thus the statistical conclusions in the earlier paper can be questioned. Whether the radiocarbon test area is anomalous is an open question. An analysis of a color photo of the Shroud indicates that it could be possible to use this photo to address this question.

ACKNOWLEDGEMENT

The author would like to acknowledge the help of Barrie Schwartz in answering questions about Vern Miller's photographic setup. Also, the posting of Vern Miller's 1978 photos on the web by Gil Lavoie and Tom D'Muhala is greatly appreciated.

REFERENCES

Adler, A.D., Selzer, R. and DeBlase, F. (2002) Further Spectroscopic Investigations of Samples of the Shroud of Turin. In: Minor, M., Adler, A.D. and Piczek, D.I., Eds., *The Shroud of Turin—Unraveling the Mystery*, Alexander Books, Alexander, 166-181.
<http://www.shroud.com/pdfs/ssi43part9.pdf>

Avis C, Lynn D, Lorre J, Lavoie S, Clark J, Armstrong E, Addington J (1982). In: *Image processing of the Shroud of Turin, 1982 Proceedings of the IEEE International Conference on Cybernetics and Society*, pp. 554-558.

CIE L*a*b Color Space, https://en.wikipedia.org/wiki/CIELAB_color_space.

Clark Labs, IDRISI GIS and Image Processing Software, <http://www.clarklabs.org>, 2011.

Damon PE, Donahue DJ, Gore BH, Hatheway AL, Jull AJT, Linick TW, Sercel PJ, Toolin LJ, Bronk CR, Hall RE, Hedges M, Housley R, Law IA, Perry C, Bonani G, Trumbore S, Woelfli W, Ambers JC, Bowman SGE, Leese MN, Tite MD, (1989). Radiocarbon dating of the Shroud of Turin, *Nature* 337(6208): 611-615.

Hotelling, H. (1933). Analysis of a complex of statistical variables into principal components. *Journal of Educational Psychology*, **24**, 417–441, and 498–520.

MATLAB®, <https://www.mathworks.com>.

Miller, V., (2019) <https://www.shroudphotos.com>.

Miller, V.D. and S.F. Pellicori, (1981). Ultraviolet fluorescence photography of the Shroud of Turin," *Journal of Biological Photography*, Vol. 49, No. 3, 1981, pp. 71-85.

Morgan, J., (2012). Digital image processing techniques demonstrating the anomalous nature of the radiocarbon dating sample area of the Shroud of Turin, *Scientific Research and Essays*, 7(29), 2641-2655.

Rogers, R. N. and Arnoldi, A., (2002). Scientific method applied to the Shroud of Turin: A review, <https://www.shroud.com/pdfs/rogers2.pdf>.

Schwartz, B., personal communication.

Van Haelst, R., (1999). Radiocarbon dating the Shroud of Turin - The Nature report, <https://www.shroud.com/vanhels5.pdf>.